

▲ HYUNDAI
MATERIAL HANDLING



STAGE



40/45/50L-9
LPG forklifts



**ECONOMICAL
ENGINE**



**HEAVY-DUTY
POWER TRAIN**



**VERY COMPACT
MACHINE**



**FULL CONTROL
CLUSTER**



**BEST STANDARD
WARRANTY**

STAGE V AND BEYOND

Hyundai's new L-9 Series is part of a fresh generation of LPG forklifts complying with the European Stage V emission levels. But it goes much further than that!

Dedicated to their mission, 'Moving you Further', our engineers aimed for a **ground-breaking level of customer satisfaction** with **maximum performance** and **productivity**, higher **operator comfort**, better **safety** and **improved uptime management**.

Combining a robust exterior design with eco-friendly, cost-effective performance, our L-9 forklifts open up new possibilities to tackle all the challenges you face in your logistics business.



Productivity & Efficiency

QUIET AND FUEL-EFFICIENT TO OPTIMISE PRODUCTIVITY

The Hyundai legacy of reliable technology continues with a robust engine in combination with a high-end LPG system and catalytic converter with proven efficiency. As well as complying with Euro Stage V emission regulations, the engine operates with reduced noise and fuel consumption. It also features a compact design that frees up space in the engine room to facilitate servicing.



Optimised fuel efficiency NEW



The L-9 Series is powered by a durable Kubota WG3800 LPG engine that produces 68.5 kW while complying with the Europe's strictest emissions standards. It also achieves **impressive cost savings** by delivering excellent performance with low fuel consumption rates.

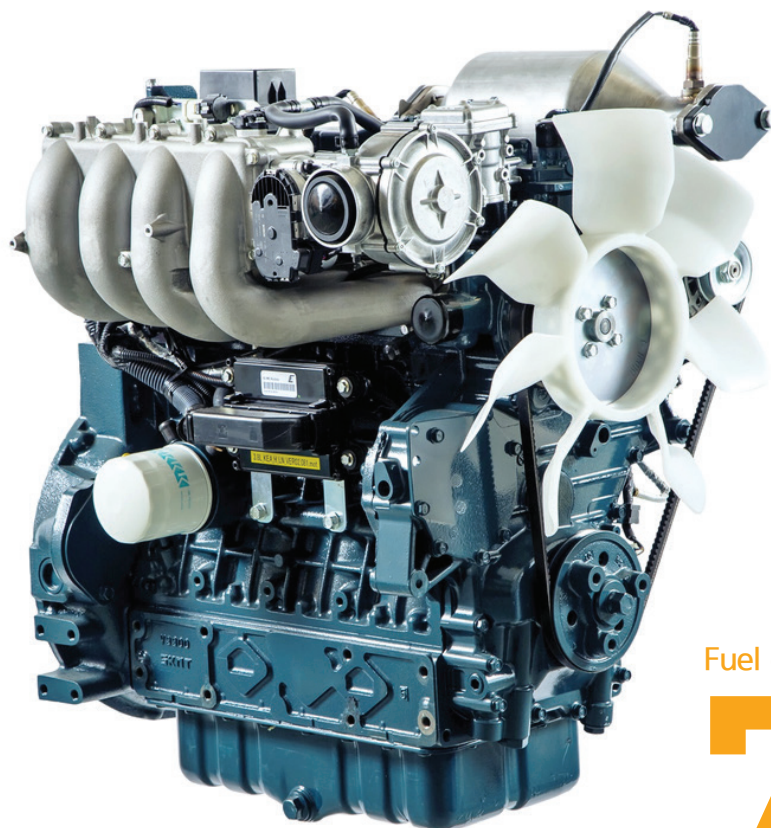

- The engine displacement and power are optimised to deliver uniform torque throughout the rpm range.
- The cooling system load has been reduced.
- Tilt line pressure has been readjusted to enhance efficiency and safety.
- Fuel efficiency has been improved by 7% by minimising hydraulic pressure losses at the lifting line.

Fuel efficiency

7% ↑

Forklift standard warranty*

2 years

or 3000 hours, whichever comes first.

Excellent driving performance

The powerful engine is combined with a new transmission and drive axle to provide faster travel speed and increased drawbar pull on any terrain.

Travel speed **24%** ↑
Drawbar pull **5.3%** ↑



Productivity & Efficiency

NEW POWERTRAIN FOR ENHANCED POWER AND DURABILITY

The L-9 Series features an optimised transmission and drive axle with wet disc brakes for unbeatable durability in the toughest applications. For greater peace of mind, the new power train (transmission + front axle) comes with an extra warranty of 1000 hours on top of the standard 2 years/3000 hours full machine warranty.

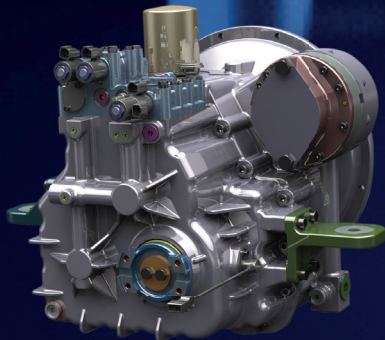

Transmission (F2/R1)

The clutch pack boosts transmission power by 25%, while increased T/M oil capacity ensures more efficiency in high-load working conditions. The reverse gear, which is used less frequently, is configured in a single step for greater durability and practicality. The DCSR system prevents high-speed directional change, reducing tyre wear and protecting the transmission to reduce running and servicing costs.

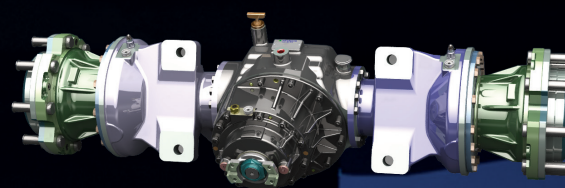

Drive axle

The drive axle is equipped with a planetary reducing gear offering resistance to torque changes. The sump capacity has been increased by 10% for better performance and durability of the wet disc brakes. The differential assembly includes a maintenance-free auto parking system.



Auto shift system

The automatic transmission has a programmable shift point for going from first to second gear. This can be programmed through the cluster. This way you can finetune your machine to the application.

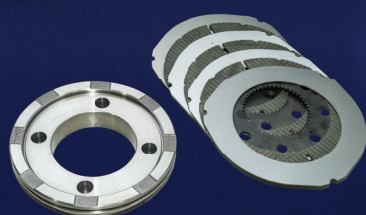

Wet disc brake

The wet disc brake system is designed for smooth performance, rapid brake cooling, high durability and minimum downtime.



Extended wheelbase

The wheelbase of the heavy-duty 45L-9 and 50L-9 has been extended by 100 mm for better stability and safety.

Operator Comfort

FIRST-CLASS ERGONOMICS FOR A PLEASANT, PRACTICAL WORKSPACE

The optional cabin is designed to provide every operator with a comfortable environment for enjoyable, productive work. The most important controls are positioned within easy reach from the deluxe seat. The layout is spacious and well thought-out to enhance operating pleasure and reduce fatigue, even during long working hours.

* Photo may include optional equipment

High-quality cabin with optional heating and air conditioning

The bolt-on type cabin is based on four main components that are easy to install and replace with original parts if necessary. Air-conditioning and/or heating can be installed as options to maintain an optimal interior temperature.

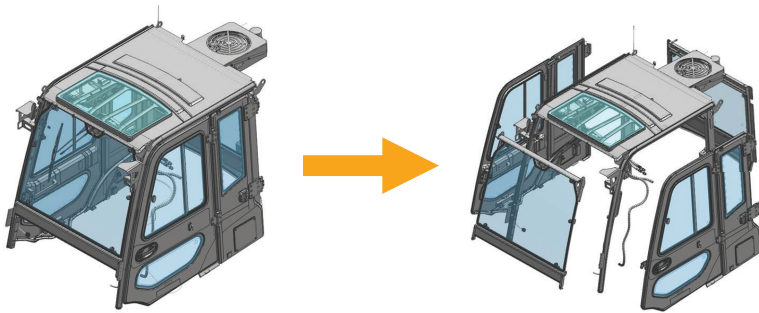

Full suspension seat



The high-quality Grammer seat features full suspension and an adjustable cushion to provide comfort for every driver. A seat belt switch, armrests and seat heating are available as options.

“The cabin is outstanding! It’s warm and quiet and the handy positioning of all the controls makes the forklift a dream to drive.”



Steering wheel



The steering wheel diameter has been reduced by 40 mm to minimise driver fatigue. A Danfoss 4th generation Orbitrol steering unit has been added to reduce noise and improve rotation.



Rear grip bar and horn OPTION

A rear grip bar with integrated horn button allows the driver to sit comfortably and sound the horn easily while reversing.

Directional switch and horn

A directional switch and horn button are integrated into the lift/lower lever for quick response and reduced fatigue.



Operator Comfort

TECHNOLOGY AT YOUR FINGERTIPS FOR FULL CONTROL

The multifunctional digital cluster makes it easy to control all key functions. Useful machine status information is included to make equipment management safer and more convenient.



Instrument cluster



The large, clear digital display allows the driver to check operating conditions in real time. An LPG reserve lamp is included as standard and various additional functions are included for safe and convenient equipment management. These include control service interval for consumables and display of the load on the forks (OPT).

“All the information I need is right in front of me. The auto tilt option gives me more confidence when I’m unloading pallets from a high rack.”

Auto tilt OPTION



Auto tilt levelling ensures that the forks remain parallel to the ground. This enhances safety and work efficiency when loading and unloading pallets on and off high racks.

Safety

CREATING A SAFER WORKING ENVIRONMENT

Small details can make a huge difference when it comes to safety and security. By helping to ensure an accident-free workplace, the new L-9 Series forklifts help you to achieve the peace of mind and productivity you need to protect your business.



Wide view from the cabin

The cylinder and hydraulic hose are arranged to provide the operator with an optimal front view. A panoramic mirror and rear camera are also included for a clear view of the surrounding area.

LED lights

LED lights (headlamp, rear work lamp and combination lamp) offer optimal visibility in all conditions.



Speed limiter

A speed limit can be programmed in advance and activated using a switch on the dashboard.



* Photo may include optional equipment

Down control function

The fork lowering speed is controlled at all times and even slows down automatically in the event of a hydraulic hose failure to prioritise safety.

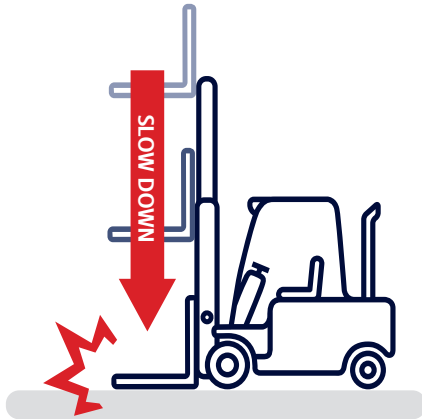

Passcode-protected start-up

Drivers can restrict equipment operation by setting a passcode. This prevents theft or accidents that could occur due to unauthorised use of the machine.



Anti-rollback system

The anti-rollback system prevents the machine from rolling back on a ramp and provides excellent ramp start performance.



OPSS (Operator Presence Sensing System)

The OPSS System restricts driving, lifting and tilting, and kicks in automatically when the operator leaves the seat to prevent accidents. It operates in conjunction with the auto parking brake to contribute to a safer workplace.



Overload warning OPTION

A real-time readout of the load weight and an overload warning lamp are displayed on the cluster.

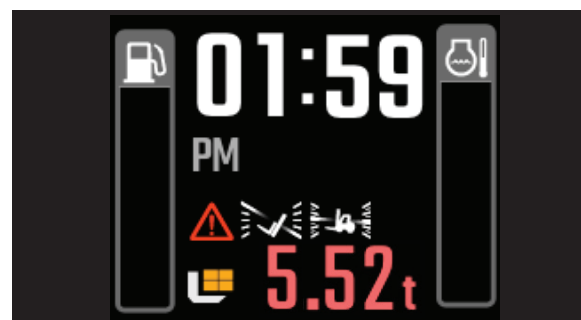

Seatbelt interlock OPTION

A seatbelt interlock system can be installed as an option. This ensures that the forklift can only be operated when the correct seatbelt procedures are observed.



Serviceability

BUILT FOR QUICK, EASY SERVICING

The peace of mind that comes with fast, low-effort servicing is also part of the Hyundai L-9 Series philosophy. These forklifts are designed to make maintenance as convenient as possible.

The engine hood opens wide and the side panels and floor plate are removable without tools to reveal a large workspace offering easy access to major parts.

All components and materials have been optimised for quick access, maximum uptime and a long, trouble-free service life.



Hi MATE for data-based machine monitoring

The new L-9 Series forklifts come with Hyundai's exclusive Hi MATE remote fleet management system, which uses mobile data technology to provide the highest level of service and support. You can monitor your equipment wherever you are via a dedicated website or mobile app, with access to working parameters like total engine hours, machine utilisation, actual performed working hours and fuel consumption and machine location. Please contact your dealer for more information.

Detachable radiator cover

The radiator is accessed via a toolless sub-hood. This makes it easy to check and clean the cooling system with minimum downtime.



Easy-to-service MCV

The MCV (hydraulic control valve) is installed horizontally to allow adjustment of the hydraulic pressure and spool exchange without opening the MCV assembly. An embedded flow regulator makes it easy to regulate the lowering speed. An emergency screw is integrated to facilitate mast lowering in an emergency.



Engine diagnostics

Engine failure codes are stored in the ECU and can be accessed via the cluster without additional diagnostic tools. This saves time and improves servicing precision.

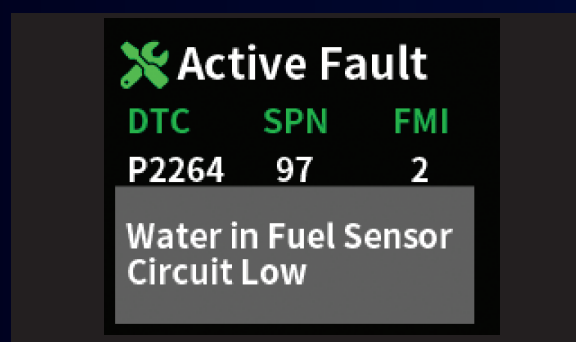

Simplified service scheduling

Replacement timing for consumables like the engine oil filter and air cleaner is displayed on the cluster screen, supporting timely servicing, optimal machine performance and durability.

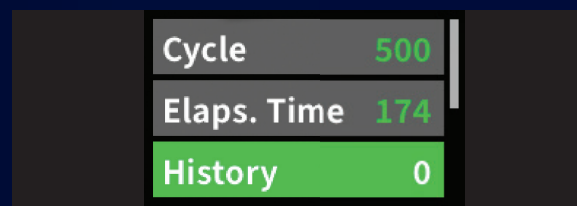

Fuse and relay boxes

The engine fuses and relays are installed in an IP67 rated box providing reliable protection against water and dust.



Standalone catalytic converter

A 3-way catalytic converter is installed separately from the silencer to reduce exhaust aftertreatment costs and maintenance.

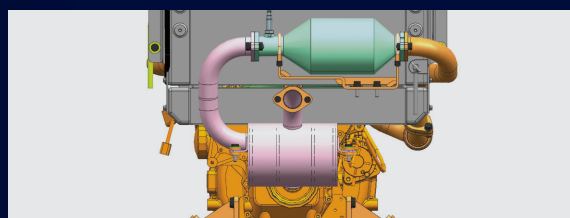

Rear dust cover

A rubber cover between the steering wheel housing and engine compartment prevents the intrusion of dirt and grit. This extends the maintenance interval for the cooling system.

Parts & Warranties

HYUNDAI GENUINE PARTS AND WARRANTIES: THE BEST WAY TO PROTECT YOUR INVESTMENT

Hyundai Genuine parts, accessories and warranty programmes are specially designed to keep your investment covered. They increase uptime and maintain the performance, comfort, and convenience that are built into your equipment.

Leader in standard warranties for battery Forklifts!

Hyundai warranties are designed to give you the cover you need to build your business with confidence and peace of mind.

Best standard warranties in the industry

For extra reassurance, and to ensure maximum customer confidence, we are supplying all new battery models with best industry standard warranties.

The forklift standard warranty covers you for two years or 3000 hours, whichever comes first.

Optional and extended warranty periods

In addition to this standard coverage, optional and extended warranty periods are available, allowing you to benefit from full warranty coverage for longer, and even over the full service life of your forklift.*

Forklift standard warranty*
2 years
or 3000 hours,
whichever comes first.



Hyundai Genuine parts

Hyundai Genuine parts have the same design as those installed when your machine left the factory. They are subjected to rigorous quality inspections and tests to make sure they meet Hyundai's strict requirements for quality and durability.

As well as minimising downtime, this helps to ensure peak performance on every task. In the 13000 m² warehouse, **Hyundai covers over 96% of all Genuine Parts.** With one of Europe's most advanced automated warehousing systems, we are able to maintain availability and efficient delivery of all our Genuine Parts.

A network you can rely on

HCEE prioritises quick, reliable intervention to keep your equipment running reliably. Thanks to the **extended dealer network across Europe, we will always be close by to ensure a timely and efficient solution.** Moreover, we guarantee a 24-hour delivery service across our European dealer network.

* Conditions apply. Please discuss the optimal solution for your needs with your dealer.



Walk-around

40/45/50L-9

Productivity & Efficiency

- Eco-friendly Euro Stage V LPG engine
- Fuel consumption rate improved by 7%
- New transmission & drive axle for improved travel speed, traction and durability
- Wet-disc brake system with prolonged service life
- Extended wheelbase
- Improved drive axles
- Improved transmission

NEW

NEW

NEW



Operator Comfort

- Enhanced instrument cluster
- Reduced steering wheel size
- Deluxe Grammer seat
- Spacious bolt-on type cabin with optional air conditioning and/or heater
- Directional switch and horn on lift/lower lever

NEW

NEW

OPTION



Safety

- Auto parking brake
- Operator Presence Sensing System (OPSS)
- Auto tilt levelling
- Load weight indicator
- Rear-view camera
- Speed limiter
- Seatbelt interlock system
- Passcode-protected start-up

OPTION**OPTION****OPTION****OPTION**

Serviceability

- Engine hood with wide opening angle
- Detachable radiator cover
- Water and dustproof fuse and relay box
- Engine diagnostics and service scheduling
- Standalone 3-way catalytic converter
- Horizontally mounted MCV
- LPG reserve warning

SPECIFICATIONS

Main characteristics					
1.1	Manufacturer	Hyundai			
1.2	Manufacturer's type designation	40L-9	45L-9	50L-9	
1.3	Drive : Electric (battery or mains), Diesel, Petrol, Fuel Gas	LPG	LPG	LPG	
1.4	Type of operation: Hand, Pedestrian, Standing, Seated, Order-Picker	Seated	Seated	Seated	
1.5	Load capacity / rated load	kg	4000	4500	5000
1.6	Load center distance	c mm	600	600	600
1.8	Load distance, center of drive axle to fork	x mm	561	561	576
1.9	Wheelbase	y mm	2000	2100	2100

Weights					
2.1	Service weight	kg	6348	6689	7058
2.2	Axle loading, loaded front/rear	kg	9062/1286	9896/1293	10698/1360
2.3	Axle loading, unloaded front/rear	kg	2742/3606	2911/3779	2898/4160

Tyres & chassis					
3.1	Tyres: Solid Rubber, Superelastic, Pneumatic, Polyurethane	Pneumatic		Pneumatic	Pneumatic
3.2	Tyre size, front	7.50-16-12PR		7.50-16-12PR	7.50-16-12PR
3.3	Tyre size, rear	7.00-12-14PR		7.00-12-14PR	7.00-12-14PR
3.5	Wheels, number front/rear (X = driven wheels)	2x2		2x2	2x2
3.6	Tread, front	b10 (mm)	1282	1282	1282
3.7	Tread, rear	b11 (mm)	1140	1140	1140

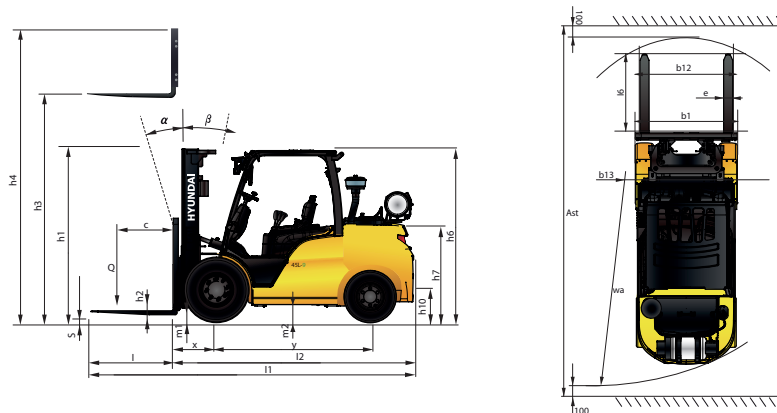

Dimensions					
4.1	Tilt of mast/fork carriage forward/backward	degrees	8/10	8/10	8/10
4.2	Lowered mast height	h1 (mm)	2220	2220	2220
4.3	Free lift	h2 (mm)	120	120	120
4.4	Lift height	h3 (mm)	3020	3020	2930
4.5	Extended mast height	h4 (mm)	4234	4234	4147
4.7	Height of overhead guard (cabin)	h6 (mm)	2210 (2340)	2210 (2340)	2210 (2340)
4.8	Seat height / stand height	h7 (mm)	1070	1070	1070
4.12	Coupling height	h10 (mm)	372	364	360
4.19	Overall length	l1 (mm)	4235	4455	4500
4.20	Length to face of forks	l2 (mm)	3165	3283	3347
4.21	Overall width	b1 (mm)	1370	1370	1370
4.22	Fork dimensions (hook type)	s x e x l mm	50x150x1070	50x150x1220	60x150x1200
4.23	Fork carriage ISO 2328, class / type A, B		III / A	III / A	III / A
4.24	Fork carriage width	b2 (mm)	1300	1300	1300
4.31	Ground clearance, below mast, loaded	m1 (mm)	155	155	155
4.32	Ground clearance, center of wheelbase	m2 (mm)	205	205	200
4.34.1	Aisle width for pallets 1000 X 1200 crossways	Ast (mm)	4677	4771	4828
4.34.2	Aisle width of pallets 800 X 1200 lengthways	Ast (mm)	4877	4971	5028
4.35	Turning radius	Wa mm	2916	3010	3052
4.36	Smallest pivot point distance	b13 (mm)	1009	1054	1054

Performance data					
5.1	Travel speed, unloaded	km/h	29.9	29.8	29.7
5.2	Lift speed, loaded/unloaded	mm/s	510/530	510/530	440/460
5.3	Lowering speed, loaded/unloaded	mm/s	550/550	550/550	550/500
5.6	Max. drawbar pull, loaded/unloaded	kg	3852	3863	3869
5.8	Max. gradeability, loaded/unloaded	%	35.5	32.6	30.1
5.10	Service brake		Hydraulic	Hydraulic	Hydraulic

Engine					
7.1	Engine manufacturer / type		KUBOTA/WG3800	KUBOTA/WG3800	KUBOTA/WG3800
7.2	Engine power acc. to ISO 1585	kW	63.5	63.5	63.5
7.3	Rated speed	1/min	2450	2450	2450
7.4	No. of cylinder / cubic capacity	anz/m ³	4/3769	4/3769	4/3769
7.5	Fuel consumption acc. to VDI (60) cycle	l/h	10.0	10.7	11.4

Additional data					
8.1	Type of drive control		Power shift 2/1	Power shift 2/1	Power shift 2/1
8.2	Operating pressure for attachments (system)	bar	140 (190)	140 (190)	140 (190)
8.3	Oil volume for attachments	l/min	60	60	60
8.4	Sound level at driver's ear according to DIN 12 053	dB(A)	99.1	99.1	99.1

※ All technical data & charts in this brochure are based on MAST V300 (35/40/45L-9) / V290 (50L-9), Hook type carriage, no side shift and fork positioner, fork 1,070 mm (35/40L-9) / 1,220 mm (45L-9) / 1,200 mm (50L-9)

MAST SPECIFICATIONS

40L-9														
Mast type		Maximum fork height	Overall height (lowered)		Free lift height		Tilt angle		Load capacity without side shift		Load capacity with side shift		Truck weight (unloaded)	
			Single tyre	Double tyre	With load backrest	Without load backrest	Fwd	Bwd	Single tyre	Double tyre	Single tyre	Double tyre	Single tyre	Double tyre
			mm	mm	mm	mm	mm	mm	deg	deg	kg	kg	kg	kg
2-stage limited free lift	V270	2720	2085	2070	120	120	8	10	4000	4000	4000	4000	6219	6340
	*V300	3020	2235	2220	120	120	8	10	4000	4000	4000	4000	6249	6370
	V330	3320	2385	2370	120	120	8	10	4000	4000	4000	4000	6287	6408
	V350	3520	2535	2520	120	120	8	10	4000	4000	4000	4000	6310	6431
	V370	3720	2635	2620	120	120	8	10	4000	4000	3950	3950	6330	6451
	V400	4020	2845	2830	120	120	8	10	4000	4000	3900	3900	6373	6493
	V430	4320	2995	2980	120	120	8	10	4000	4000	3850	3850	6429	6550
	V450	4520	3095	3080	120	120	8	6	4000	4000	3800	3800	6486	6606
	V500	5020	3345	3330	120	120	8	6	3900	4000	3700	3700	6536	6657
2-stage full free lift	VF280	2805	2135	2120	916	1243	8	8	4000	4000	4000	4000	6225	6377
	VF300	3005	2235	2220	1016	1343	8	8	4000	4000	4000	4000	6251	6404
	VF315	3155	2325	2310	1106	1433	8	8	4000	4000	4000	4000	6271	6423
3-stage full free lift	TF/TS370	3730	2035	2020	807	1134	8	8	4000	4000	3900	3950	6476	6597
	TF/TS400	4030	2135	2120	907	1234	8	8	4000	4000	3850	3850	6506	6627
	TF/TS430	4330	2235	2220	1007	1334	8	8	4000	4000	3800	3800	6537	6658
	TF/TS450	4510	2295	2280	1067	1394	8	8	4000	4000	3800	3800	6556	6677
	TF/TS470	4720	2385	2370	1157	1484	8	8	4000	4000	3700	3750	6593	6713
	TF/TS500	5020	2485	2470	1257	1584	8	6	3900	3900	3600	3650	6616	6736
	TF/TS550	5520	2665	2650	1437	1764	8	6	3700	3800	3350	3500	6677	6797
	TF/TS600	6030	2845	2830	1617	1944	8	6	3600	3600	2950	3400	6745	6866
	TF/TS650	6540	3025	3010	1797	2124	8	6	3500	3500	2850	3300	6787	6907

45L-9														
Mast type		Maximum fork height	Overall height (lowered)		Free lift height		Tilt angle		Load capacity without side shift		Load capacity with side shift		Truck weight (unloaded)	
			Single tyre	Double tyre	With load backrest	Without load backrest	Fwd	Bwd	Single tyre	Double tyre	Single tyre	Double tyre	Single tyre	Double tyre
			mm	mm	mm	mm	mm	mm	deg	deg	kg	kg	kg	kg
2-stage limited free lift	V270	2720	2085	2070	120	120	8	10	4500	4500	4500	4500	6559	6685
	*V300	3020	2235	2220	120	120	8	10	4500	4500	4500	4500	6589	6715
	V330	3320	2385	2370	120	120	8	10	4500	4500	4500	4500	6626	6753
	V350	3520	2535	2520	120	120	8	10	4500	4500	4500	4500	6650	6776
	V370	3720	2635	2620	120	120	8	10	4500	4500	4400	4400	6670	6796
	V400	4020	2845	2830	120	120	8	10	4500	4500	4350	4350	6712	6839
	V430	4320	2945	2980	120	120	8	10	4500	4500	4300	4300	6769	6895
	V450	4520	3095	3080	120	120	8	6	4500	4500	4200	4200	6825	6951
	V500	5020	3345	3330	120	120	8	6	4400	4400	4050	4050	6876	7002
2-stage full free lift	VF280	2805	2135	2120	853	1442	8	8	4500	4500	4500	4500	6595	6721
	VF300	3005	2235	2220	953	1542	8	8	4500	4500	4500	4500	6621	6747
	VF315	3155	2325	2310	1043	1602	8	8	4500	4500	4500	4500	6640	6767
3-stage full free lift	TF/TS370	3730	2035	2020	796	1114	8	8	4500	4500	4350	4350	6816	6945
	TF/TS400	4030	2135	2120	896	1214	8	8	4500	4500	4300	4300	6846	6975
	TF/TS430	4330	2235	2220	996	1314	8	8	4500	4500	4200	4200	6877	7006
	TF/TS450	4510	2295	2280	1056	1374	8	8	4500	4500	4150	4150	6896	7025
	TF/TS470	4720	2385	2370	1145	1484	8	8	4400	4400	4100	4100	6932	7061
	TF/TS500	5020	2485	2470	1246	1564	8	6	4300	4300	4000	4000	6955	7084
	TF/TS550	5520	2665	2650	1426	1744	8	6	4200	4200	3850	3850	7016	7145
	TF/TS600	6030	2845	2830	1606	1924	8	6	4000	4000	3250	3750	7085	7214
	TF/TS650	6540	3025	3010	1786	2104	8	6	3900	3900	3150	3650	7126	7255

* Standard

50L-9														
Mast type		Maximum fork height	Overall height (lowered)		Free lift height		Tilt angle		Load capacity without side shift		Load capacity with side shift		Truck weight (unloaded)	
			Single tyre	Double tyre	With load backrest	Without load backrest	Fwd	Bwd	Single tyre	Double tyre	Single tyre	Double tyre	Single tyre	Double tyre
									600 mm LC	600 mm LC	600 mm LC	600 mm LC		
		mm	mm	mm	mm	mm	deg	deg	kg	kg	kg	kg	kg	kg
2-stage limited free lift	V260	2630	2085	2070	120	120	8	10	5000	5000	5000	5000	6952	7040
	*V290	2930	2235	2220	120	120	8	10	5000	5000	5000	5000	7028	7116
	V320	3230	2385	2370	120	120	8	10	5000	5000	5000	5000	7002	7091
	V340	3430	2535	2520	120	120	8	10	5000	5000	4950	4950	7027	7115
	V360	3630	2635	2620	120	120	8	10	5000	5000	4900	4900	7043	7132
	V390	3930	2845	2830	120	120	8	10	5000	5000	4800	4800	7079	7167
	V440	4430	3095	3080	120	120	8	6	4900	5000	4650	4650	7182	7270
	V490	4930	3345	3330	120	120	8	6	4800	4900	4500	4500	7224	7313
	VF270	2702	2135	2120	905	1223	8	8	5000	5000	4700	5000	7011	7096
2-stage full free lift	VF290	2902	2235	2220	1005	1323	8	8	5000	5000	4650	5000	7036	7121
	VF305	3052	2325	2310	1095	1413	8	8	5000	5000	4550	5000	7054	7139
	TF/TS360	3672	2035	2020	807	1074	8	8	5000	5000	4700	4800	7195	7272
3-stage full free lift	TF/TS390	3972	2135	2120	907	1174	8	8	5000	5000	4650	4700	7222	7298
	TF/TS420	4272	2235	2220	1007	1274	8	8	4900	5000	4550	4600	7247	7323
	TF/TS440	4452	2295	2280	1067	1334	8	8	4800	5000	4500	4550	7263	7339
	TF/TS460	4662	2385	2370	1157	1424	8	8	4700	4900	4450	4500	7286	7363
	TF/TS490	4962	2485	2470	1257	1524	8	6	4600	4800	4350	4450	7312	7388
	TF/TS540	5462	2665	2650	1437	1704	8	6	4500	4700	4250	4300	7364	7440
	TF/TS590	5972	2845	2830	1617	1884	8	6	4400	4600	4100	4200	7404	7480
	TF/TS640	6482	3025	3010	1797	2064	8	6	4300	4500	4000	4100	7445	7522
	TF/TS650	6540	3025	3010	1797	2124	8	6	3500	3500	2850	3300	6787	6907

* Standard

LOAD CAPACITY

40L-9

V-mast / no attachment / single tyres / 1070 mm fork

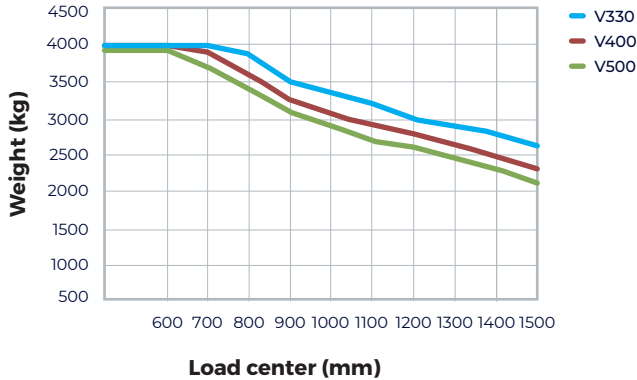

45L-9

V-mast / no attachment / single tyres / 1220 mm fork

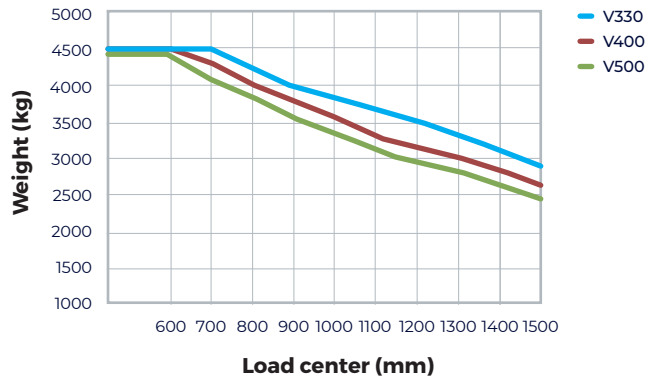

40L-9

VF-mast / no attachment / single tyres / 1070 mm fork

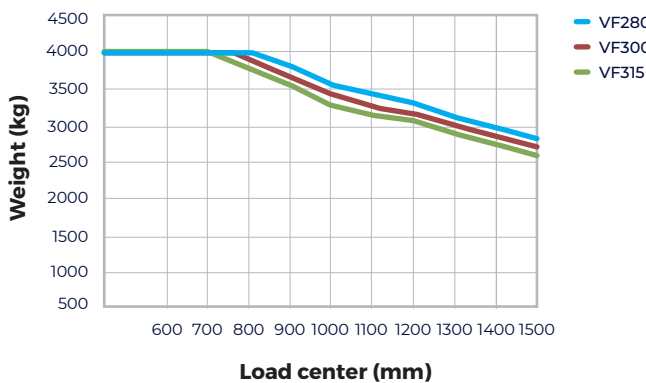

45L-9

VF-mast / no attachment / single tyres / 1220 mm fork

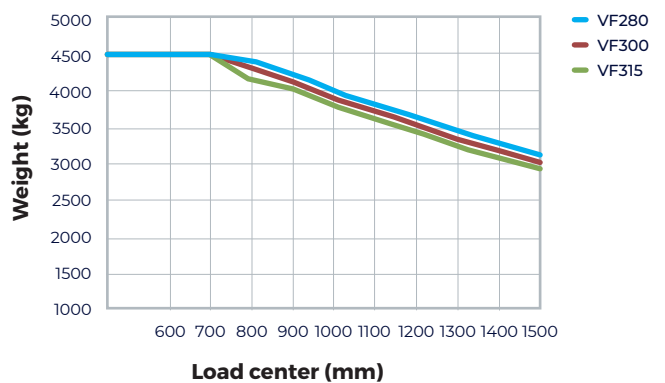

40L-9

TF-mast / no attachment / single tyres / 1070 mm fork

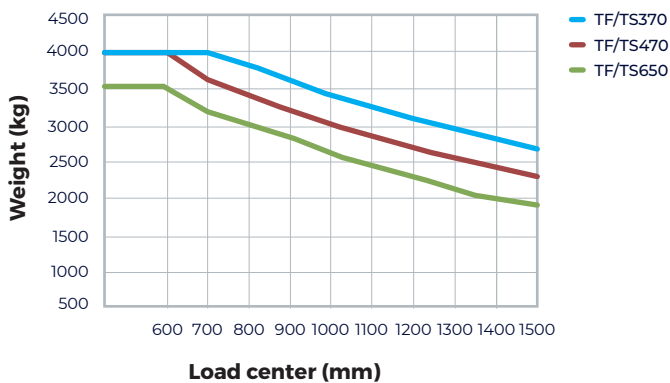

45L-9

TF-mast / no attachment / single tyres / 1220 mm fork

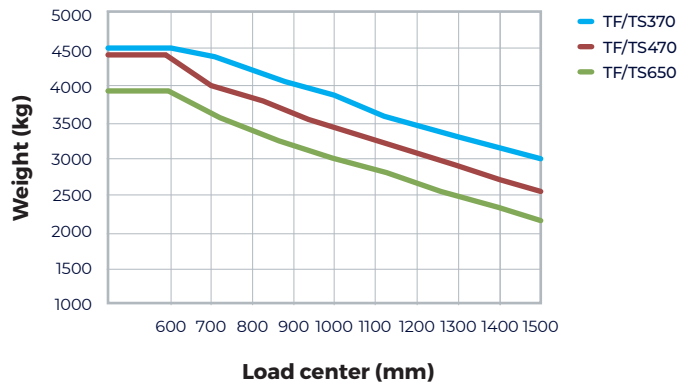

50L-9

V-mast / no attachment / single tyres / 1200 mm fork

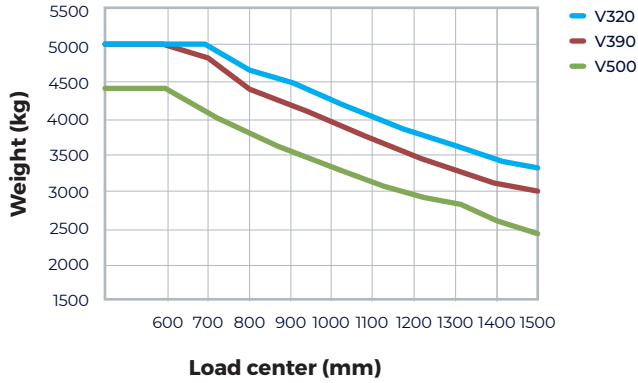

50L-9

VF-mast / no attachment / single tyres / 1200 mm fork

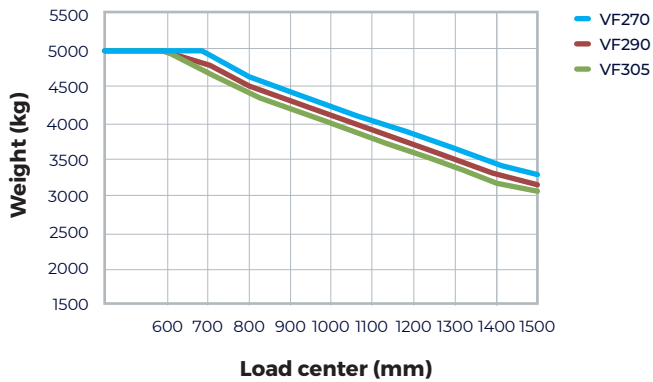

50L-9

TF-mast / no attachment / single tyres / 1200 mm fork

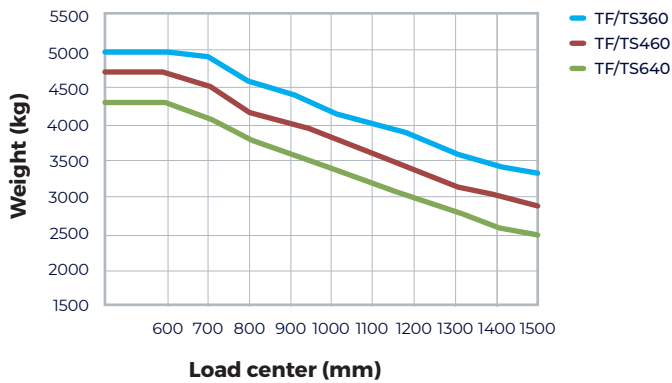

STANDARD AND OPTIONAL EQUIPMENT

Part	Description	40L-9	45L-9	50L-9	
OPERATOR AREA	OHG	Overhead guard *40/45/50L-9: 2210 mm	•	•	•
		High overhead guard *40/45/50L-9: 2340 mm	○	○	○
		Overhead guard & rain cover *40/45/50L-9: 2220 mm	○	○	○
		High overhead guard & rain cover *40/45/50L-9: 2350 mm	○	○	○
	Cabin	Cabin options - full cabin, one door, two door	○	○	○
		Cabin accessories - overhead guard with rain cover or partial cabin (front with wiper + rear + top)	○	○	○
	A/C	Air conditioner and heater The air conditioning system contains fluorinated greenhouse gas refrigerant R134a. (Global Warming Potential: 1,430) The system contains 0.55 kg refrigerant representing a CO2 equivalent of 0.787 metric tonnes.	○	○	○
		Heater only	○	○	○
	Seat	Full suspension synthetic leather seat + orange belt, seat switch	•	•	•
		Seat accessories - back rest, seat switch, belt switch, heat, armrest(s)	○	○	○
	Lever	Manual levers with direction switch and horn button on lift lever	•	•	•
	Others	Radio & USB (full cabin only)	○	○	○
Rear grip with horn button		○	○	○	
MAST & ATTACHMENT	Mast	2 Stage mast - standard (V), single full free (VF)	•	•	•
		3 Stage mast - single full free (TF), dual full free (TS)	○	○	○
	Fork	1220 mm fork (1200 mm for 50L-9)	•	•	•
		Fork options - 1070 mm ~ 2300 mm	○	○	○
	Carriage	Carriage - narrow (1300 mm/hook)	•	•	•
		Carriage options - Wide (1600 mm/hook)	○	○	○
Attachment possibilities	Hook-on side shift, cascade	○	○	○	
	Hook-on side shift with fork positioner (simultaneous)	○	○	○	
HYDRAULICS	MCV & Hoses	4 Spool MCV	•	•	•
		MCV options - 3 spool	○	○	○
		MCV options - 5 spool	○	○	○
		Attached piping for all MCVs & masts	○	○	○
TYRES	Tyres	Solid tyres	•	•	•
		Tyre options	-	-	-
		- Pneumatic	○	○	○
		- SE non-marking	○	○	○
		- Front pneumatic + rear solid	○	○	○
		- Front solid + rear pneumatic	○	○	○
		- Pneumatic double (15" wheel rim)	○	○	○
- Solid double (15" wheel rim)	○	○	○		
VISIBILITY	Lamp	Working lamp - front LED	•	•	•
		Working lamp options - Front LED, Front Halogen, Front LED + Rear LED, Front Halogen + Rear Halogen, Front LED + Rear Bluespot, Front Halogen + Rear Bluespot	○	○	○
		LED beacon lamp	○	○	○
Mirror	Mirror - L/H & R/H back mirror & panoramic mirror	•	•	•	
Camera	Rear camera	○	○	○	
CONVENIENCE	-	Auto tilt	○	○	○
		Load sensor	○	○	○
		Speed limiter	•	•	•
		Seat belt interlock	○	○	○
SAFETY	-	OPSS - Travel & Mast	•	•	•
		Master switch to cut off electricity from battery	•	•	•
OTHERS	-	Recycling: extra fenders and under cover	○	○	○
		Oil-VG46	•	•	•
		Oil options - VG68 for tropical areas, VG15 & VG32 for cold areas	○	○	○
		Accumulator for mast damping	○	○	○
		Hi MATE (standard version)	○	○	○
		Hi MATE (extensive version with driver authentication and collision detection)	○	○	○
Special colour	○	○	○		





*Standard and optional equipment may vary by country.
Contact your Hyundai dealer for more information.

*The machine may vary according to International
standards. European specifications may differ from
Korean specifications mentioned in the brochures.

*The photos may include attachments and optional
equipment that are not available in your area.

*Materials and specifications are subject to change
without advance notice.

Hyundai Material Handling Europe
Hyundailaan 4, 3980 Tessenderlo, Belgium
Tel: (+32) 14-56-2200 Fax: (+32) 14-59-3405

Contact your Hyundai dealer.
hyundai-mh.eu



Address